

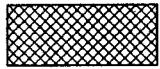

round-section cords



square-section cords



special profiles

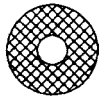

hoses



Profiles of rubber, sponge rubber,
silicone, foam silicone

silicone foam profiles

foam silicone round-section cords (SFR)

Ø mm	Colour	Article-No.
1	w	5454
1,5	w	5406
2	w	3923
2,5	w	5485
3	w	3213
3,5	w	5483
4	w	0489
4,5	w	1271
5	w	0490
5,5	w	0491
6	w	0492
6,5	w	0493

Ø mm	Colour	Article-No.
7	w	0494
8	w	0495
10	w	0496
12	w	0497
15	w	0498
18	w	0499
20	w	0500
22	w	5484
25	w	1371
30	w	3885
35	w	5751
40	w	5973

foam silicone square-section cords (SFSV/SFVS)

High mm	Wide mm	Colour	Article-No.	with SA Article-No.
1,5	20	w	5509	3557
2	20	w	0205	0487
2	30	w	5511	3920
3	5	w	0407	0488
3	8	w	3568	3569
3	10	w	0408	0578
3	15	w	0409	0579
3	16	w	0410	0580
3	20	w	0411	0581
3	25	w	0412	0582
3	30	w	0413	0583
3	35	w	0437	0584
4	5	w	0415	0585
4	10	w rb	0416 3028	0586
4	15	w	0417	0587
4	20	w rb	0418 1983	0588
4	22	w	0419	0589
4,5	10	w	0420	0590
4,5	15	w	0421	0591
4,5	70	g	3382	
4,75	25,4	w	0422	0592
5	5	g	3105	3244
5	6	w	0414	0593
5	8	w	0423	0594
5	10	w	0424	0595
5	15	w	0425	0596

High mm	Wide mm	Colour	Article-No.	with SA Article-No.
5	20	w	0426	0597
5	22,5	w	0427	0598
5	25	w	0428	0599
5	30	w g	0529 3243	0600 5522
5	40	w	0430	0601
5	50	w	5733	
5	59	g	3664	
5	70	g	3512	
5	80	g	3242	
6	6	w	3674	3724
6	8	w	0438	0608
6	15	w	0431	0602
6	16	w	0432	0603
6	20	w	0433	0604
6	40	w	0434	0605
6	50	w	0435	0606
7	12	w	4455	5531
7	15	w	0436	0607
8	8	w	0439	0609
8	10	w	0440	0610
8	14	w	0441	0611
8	15	w	0442	0612
8	20	w	0443	0613
8	24	w	0444	0614
8	35	w	0445	0615
8	38	w	0446	0616

foam silicone square-section cords (SFV/SFVS)

High mm	Wide mm	Colour	Article-No.	with SA Article-No.
9	13	w	0447	0617
9	20	w	0449	0619
9,5	14	w	0448	0618
10	10	w	1272	1274
10	12	w	3574	3774
10	15	w	0450	0620
10	18	w	2013	5539
10	20	w	0451	0621
10	25	w s	0452	0622 4365
10	30	w	0453	0623
10	35	w	0454	0624
10	40	w	5569	
10	50	w	5577	
10	45	w	0455	0625
11	16	w	0456	0626
12	12	w	0460	0627
12	15	w	0471	0628
12	25	w	5286	
12	30	w	0472	0629
12	35	w	0473	0630
12	40	w	0474	0631
15	15	w	0475	0632
15	17	w	0476	0633
15	18,5	w	0477	0634
15	20	w rb	0478 3205	0635

High mm	Wide mm	Colour	Article-No.	with SA Article-No.
15	25	w g	0479 4342	0636
15	30	w	0480	0637
15	40	w	1228	5551
15	50	w	0482	0638
16	18	w	0481	0639
16	20	w	0483	0640
17	20	w	0457	0641
18	18	w	1618	5556
18	23	w	0459	0643
18,5	20	w	0461	0644
20	20	w rb	0462 3845	0645
20	25	w	1554	2164
20	30	w	0463	0646
20	32	w	2946	5564
20	40	w	3891	5567
20	50	w	0464	0647
20	70	w	0465	0648
22	22	w	0466	0649
23	25	w	0467	0650
24	24	w	0468	0651
25	25	w g	0469 4341	0652
25	30	w	3185	3187
25	40	w	5246	
25	50	w	5647	
25	65	w	3827	

foam silicone square-section cords (SFV/SFVS)

High mm	Wide mm	Colour	Article-No.	with SA Article-No.
30	30	w	0470	0653
30	40	w g	5343 4434	
30	40	w	3550	5575
35	35	w	2160	2162
40	40	w	2794	2796

Legend

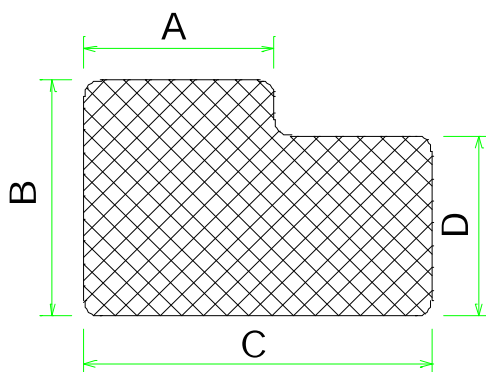

509 9 9

means

Profile-No.

EP / s / 9999 / (9998)

means

Quality / Colour / Article-No. / (Article-No. with SA)

SA = self adhesive

Quality

CR	Neoprene
EP	EPDM
NBR	Perbunan
NK	Natural rubber
Si	Silicone
SPS	Foam silicone
FPM	VITON®
PVC	Soft-PVC
EVA	Ethylenvinylacetat
SBR	Buna (Styrol-Butadien)

Colours

s	black
g	grey
w	white
az	anthracite
bg	beige
br	brown
hg	light-grey
rb	red-brown
t	translucent
r	red
x	colour selectable

List of abbreviations

SSR	Foam silicone round-section cords
SSV	Foam silicone square-section cords
SSVS	Foam silicone square-section cords with SA
SSS	Foam silicone special profiles
SSSS	Foam silicone special profiles with SA

VITON® = Entered registered trade mark of the company DuPont

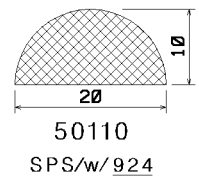
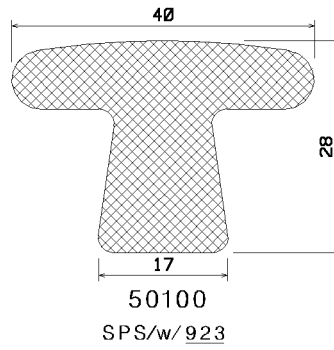
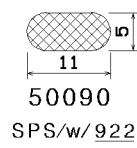
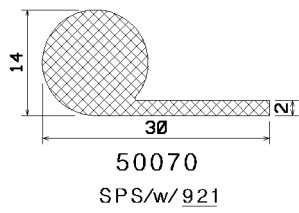
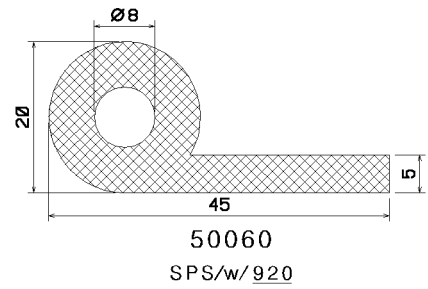
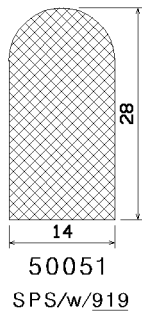
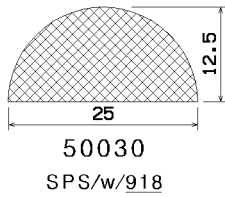
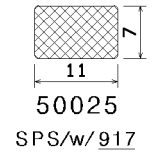
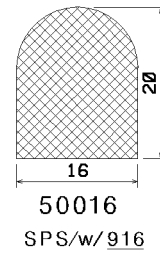
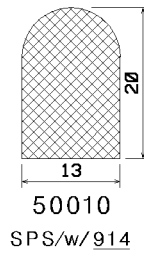
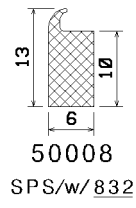
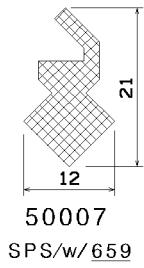
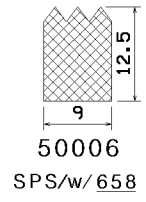
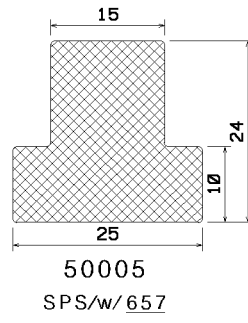
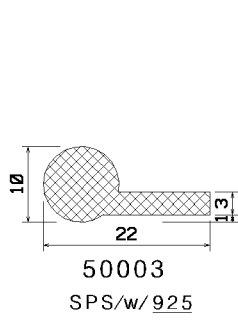
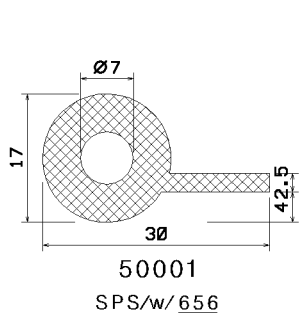

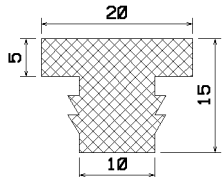

50130
SPS/w/3219

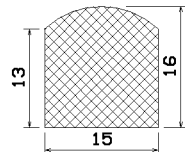

50140
SPS/rb/3288

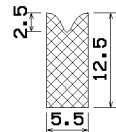

50150
SPS/w/3458

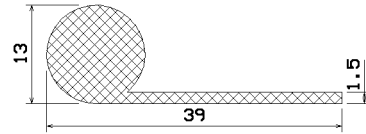

50160
SPS/w/3567

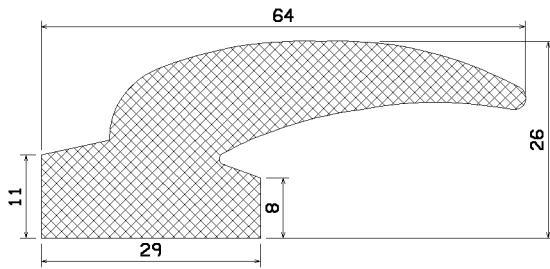

50170
SPS/w/3590

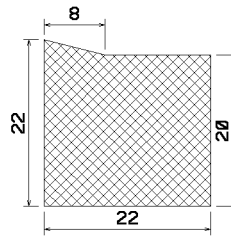

50180
SPS/w/3609

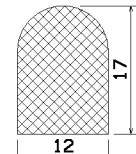

50190
SPS/w/3707

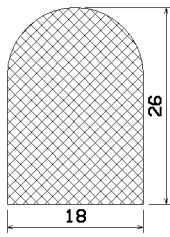

50200
SPS/a/3820

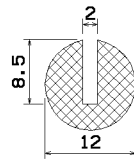

50210
SPS/w/3889

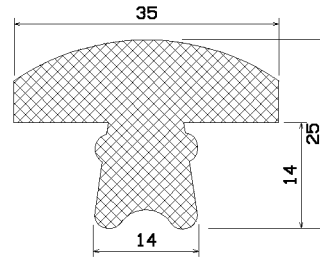

50220
SPS/w/3916

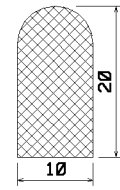

50240
SPS/w/4124

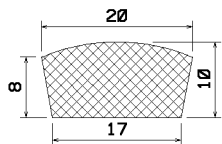

50250
SPS/rb/2321

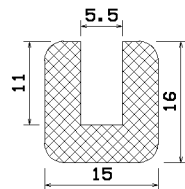

50260
SPS/w/1871

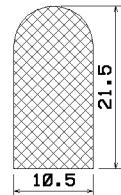

50270
SPS/w/4787

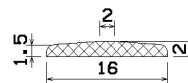

50280
SPS/w/4833/(4834)

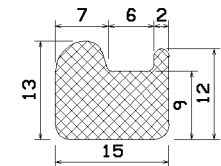

50290
SPS/w/5243

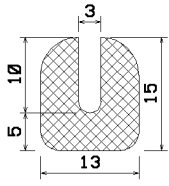

50300
SPS/w/5312

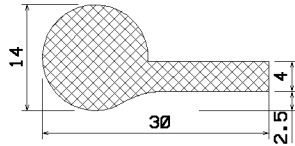

50310
SPS/w/5324

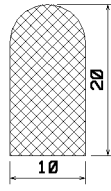

50320
SPS/rb/5443

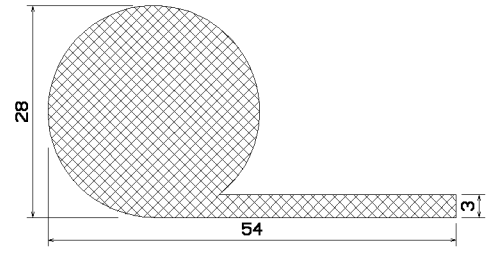

50330
SPS/w/5494

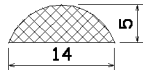

50340
SPS/w/5716

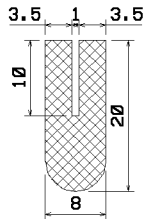

50350
SPS/w/5809

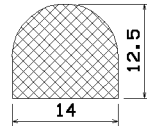

50360
SPS/w/5833

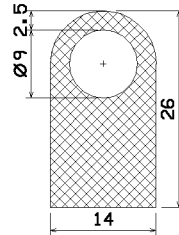

50370
SPS/w/5914



50380
SPS/s/5957/(5958)



50390
SPS/s/5959/(5960)

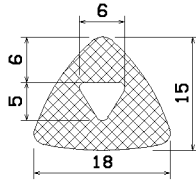

50400
SPS/w/5983

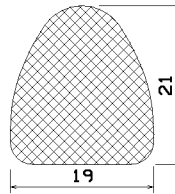

50420
SPS/rb/6027

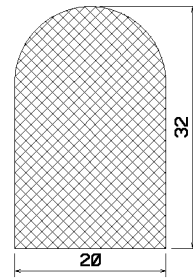

50430
SPS/rb/6561

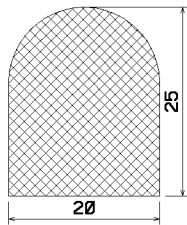

50440
SPS/rb/6828

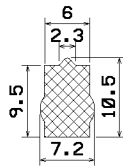

50450
SPS/w/6889

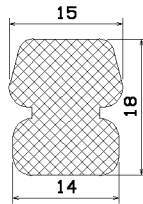

50460
SPS/w/6923

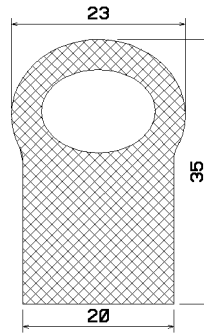

50470
SPS/rb/6935

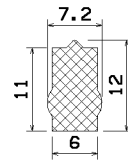

50480
SPS/w/7172

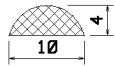

50490

SPS/rb/7192

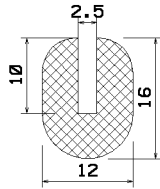

50500

SPS/w/7237

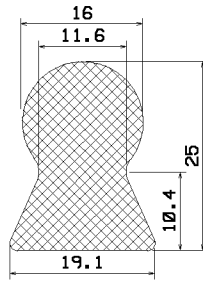

50510

SPS/w/7328

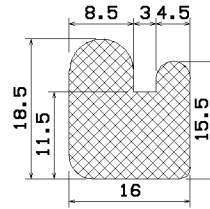

50520

SPS/rb/7347

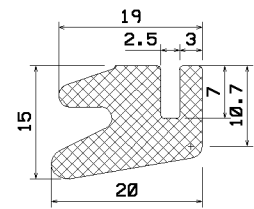

50530

SPS/w/7605

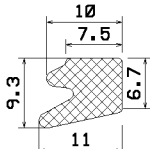

50540

SPS/w/7606

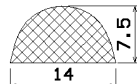

50550

SPS/hg/7699

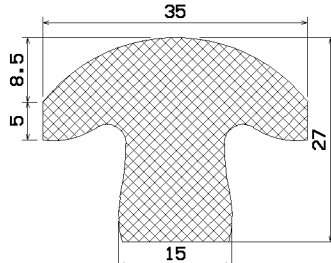

50560

SPS/w/7732

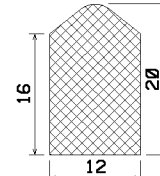

50570

SPS/w/7876

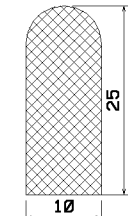

50580

SPS/rb/8002

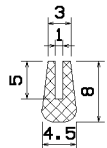

50590

SPS/az/8109

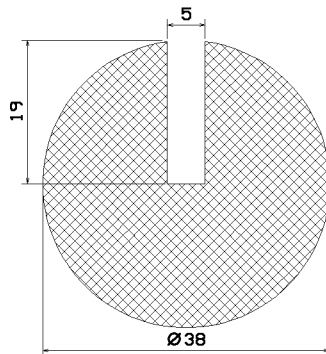

50600

(FT)

SPS/w/8247

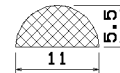

50620

SPS/w/8248

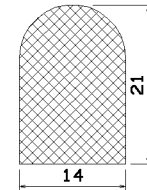

50630

SPS/w/8269

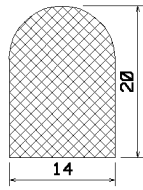

50640

SPS/w/8296

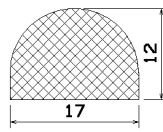

50650

SPS/w/7395

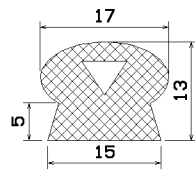

50660

SPS/w/7424

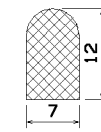

50670

SPS/w/8411

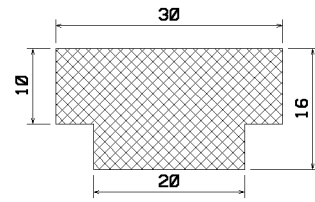

50680

SPS/w/8424

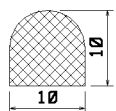

50690

SPS/w/8573

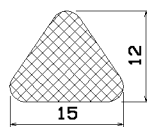

50700

SPS/w/8609

50710

(FT)

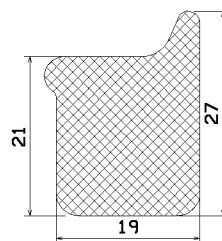

50720

SPS/w/9008

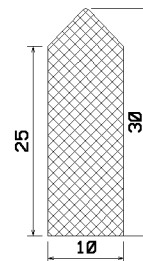

50730

SPS/w/9015